



Report

2016 Dodge Journey R/T

85,019 mi | VIN: 3C4PDDEG6GT106644

CARFAX HAS THE MOST ACCIDENT & DAMAGE INFORMATION



DAMAGE Minor Damage



Minor

Moderate

Severe

29 Service History Records

2 Previous Owners

Types of Owners: Personal Lease, Personal

Last Owned in Texas

52 Detailed Records Available



Accident / Damage History

Not all accidents / issues are reported to CARFAX

Event 1

03/24/2019

Damage reported: minor damage

Damage Severity Scale



Minor

Moderate

Severe

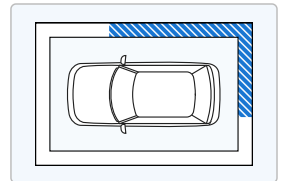

Recent Service Highlights

Key services performed in the last 12 months

Service	Comments	Date
Oil	✓ Oil and filter changed	05/08/2026

This car has been recently serviced. That's a good thing!



Additional History

Not all accidents / issues are reported to CARFAX



Owner 1

Owner 2





Total Loss No total loss reported to CARFAX.	✔ No Issues Reported	✔ No Issues Reported
Structural Damage CARFAX recommends that you have this vehicle inspected by a collision repair specialist.	✔ No Issues Reported	✔ No Issues Reported
Airbag Deployment No airbag deployment reported to CARFAX.	✔ No Issues Reported	✔ No Issues Reported
Odometer Check No indication of an odometer rollback.	✔ No Issues Indicated	✔ No Issues Indicated
Accident / Damage Damage reported: 03/24/2019.	✔ No Issues Reported	Minor Damage
Manufacturer Recall No open recalls reported to CARFAX.	✔ No Recalls Reported	✔ No Recalls Reported
Basic Warranty Original warranty estimated to have expired.	Warranty Expired	Warranty Expired

CARFAX Title History CARFAX guarantees the information in this section	Owner 1	Owner 2
Damage Brands Salvage Junk Rebuilt Fire Flood Hail Lemon	✔ Guaranteed No Problem	✔ Guaranteed No Problem
Odometer Brands Not Actual Mileage Exceeds Mechanical Limits	✔ Guaranteed No Problem	✔ Guaranteed No Problem
 GUARANTEED - None of these title problems were reported by a U.S. state Department of Motor Vehicles (DMV). If you find that any of these title problems were reported by a DMV and not included in this report, you may qualify. View Terms View Certificate		

CARFAX Ownership History The number of owners is estimated	Owner 1	Owner 2
Year purchased	2015	2018
Type of owner	Personal Lease	Personal
Estimated length of ownership	2 yrs. 4 mo.	7 yrs. 11 mo.
Owned in the following states/provinces	Michigan, Illinois	Illinois, Texas
Estimated miles driven per year	5,940/yr	8,969/yr
Last reported odometer reading	13,986	85,019

CARFAX Detailed History			
 Owner 1 Purchased: 2015	<div style="border: 1px solid #00aaff; padding: 5px;"> Low mileage! This owner drove less than the industry average of 15,000 miles per year. </div>		Personal Lease Vehicle 5,940 mi/yr
Date	Mileage	Source	Comments
12/09/2015	5	Sterling Heights Dodge Sterling Heights, MI 586-939-3900 sterlingheightsdodge.net ★ 4.0 / 5.0 77 Verified Reviews	 Vehicle serviced -Pre-delivery inspection completed

♥ 2 Customer Favorites

12/10/2015		Michigan Motor Vehicle Dept. Clinton Township, MI		Registration issued or renewed -Titled or registered as personal lease vehicle
12/11/2015		Michigan Motor Vehicle Dept. Clinton Township, MI		Loan or lien reported
12/11/2015	8	Michigan Motor Vehicle Dept. Clinton Township, MI Title #603D3441054		Title issued or updated -First owner reported
07/08/2016	3,575	Sterling Heights Dodge Sterling Heights, MI 586-939-3900 sterlingheightsdodge.net ★ 4.0 / 5.0 77 Verified Reviews ♥ 2 Customer Favorites		Vehicle serviced -Maintenance inspection completed -Oil and filter changed
07/21/2016		Michigan Motor Vehicle Dept. Clinton Township, MI		Registration issued or renewed
10/18/2016	5,215	Sterling Heights Dodge Sterling Heights, MI 586-939-3900 sterlingheightsdodge.net ★ 4.0 / 5.0 77 Verified Reviews ♥ 2 Customer Favorites		Vehicle serviced -Maintenance inspection completed -Oil and filter changed
07/12/2017		Michigan Motor Vehicle Dept. Clinton Township, MI		Registration issued or renewed
04/16/2018	13,965	Auto Auction		Vehicle sold <div style="border: 1px solid blue; padding: 5px; margin-top: 5px;">Millions of used vehicles are bought and sold at auction every year.</div>
04/23/2018		Woody Buick GMC Gurnee Gurnee, IL 847-250-0674 woodybuickgmcgurnee.com/ ★ 4.6 / 5.0 495 Verified Reviews ♥ 7,206 Customer Favorites		Vehicle serviced -Oil and filter changed -Tire condition and pressure checked
04/26/2018		Dealer Inventory		Vehicle offered for sale
06/18/2018	13,986	Gurnee Chrysler Dodge Jeep RAM Gurnee, IL 888-508-6434 gurneechryslerjeepdodgeram.com ★ 4.4 / 5.0 386 Verified Reviews ♥ 4,082 Customer Favorites		Vehicle serviced -Maintenance inspection completed -PCM reprogrammed
07/17/2018		Illinois Motor Vehicle Dept.		Vehicle purchase reported
07/24/2018		Marino Chrysler Jeep Dodge Chicago, IL 773-777-2000		Vehicle serviced -Maintenance inspection completed -Steering/suspension checked

marinocjd.com

★ 4.5 / 5.0 1,225 Verified Reviews

♥ 15,312 Customer Favorites

07/24/2018



Illinois
Motor Vehicle Dept.
Chicago, IL

Registration issued or renewed

 **Owner 2**
Purchased: 2018

Low mileage! This owner drove less than the industry average of 15,000 miles per year.

Personal Vehicle
8,969 mi/yr

Date	Mileage	Source		Comments
07/24/2018	14,001	Illinois Motor Vehicle Dept. Chicago, IL Title #182056918650		Title issued or updated -New owner reported -Loan or lien reported -Vehicle color noted as White
10/18/2018	16,445	Marino Chrysler Jeep Dodge Chicago, IL 773-777-2000 marinocjd.com ★ 4.5 / 5.0 1,225 Verified Reviews ♥ 15,312 Customer Favorites		Vehicle serviced -Maintenance inspection completed -Torque converter replaced -Transmission serviced
10/27/2018	16,711	Pep Boys Elmwood Park, IL 773-889-6395 pepboys.com ★ 4.1 / 5.0 156 Verified Reviews ♥ 109 Customer Favorites		Vehicle serviced -Maintenance inspection completed -Oil and filter changed -Tires rotated
11/06/2018	16,985	Marino Chrysler Jeep Dodge Chicago, IL 773-777-2000 marinocjd.com ★ 4.5 / 5.0 1,225 Verified Reviews ♥ 15,312 Customer Favorites		Vehicle serviced -Maintenance inspection completed -Transmission serviced

03/24/2019

Damage Report

Damage reported: minor damage

- Damage to rear
- Damage to right rear
- Damage to right side

Damage Severity Scale



Minor

Moderate





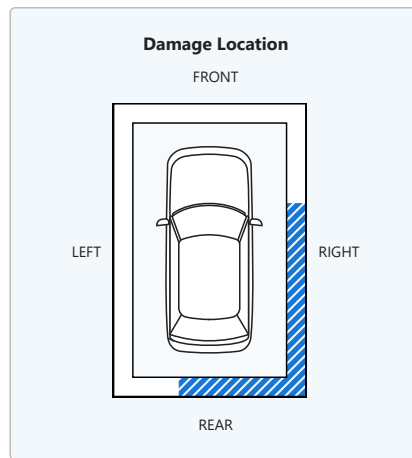

Severe







**CARFAX HAS THE MOST
ACCIDENT & DAMAGE
INFORMATION**





Minor damage is usually cosmetic, including dents or scratches to the vehicle body.

06/16/2019		Illinois Motor Vehicle Dept. Chicago, IL		Registration issued or renewed
07/16/2019	23,459	Marino Chrysler Jeep Dodge Chicago, IL 773-777-2000 marinocjd.com ★ 4.5 / 5.0 1,225 Verified Reviews ♥ 15,312 Customer Favorites		Vehicle serviced -Maintenance inspection completed -Engine checked
10/05/2019	25,160	Marino Chrysler Jeep Dodge Chicago, IL 773-777-2000 marinocjd.com ★ 4.5 / 5.0 1,225 Verified Reviews ♥ 15,312 Customer Favorites		Vehicle serviced -Maintenance inspection completed -Oil and filter changed -Tires rotated
06/29/2020	30,210	Marino Chrysler Jeep Dodge Chicago, IL 773-777-2000 marinocjd.com ★ 4.5 / 5.0 1,225 Verified Reviews ♥ 15,312 Customer Favorites		Vehicle serviced -Maintenance inspection completed -Oil and filter changed -Tires rotated
07/10/2020		Illinois Inspection Station Skokie, IL		Passed emissions inspection
07/10/2020		Illinois Motor Vehicle Dept. Chicago, IL		Registration issued or renewed -Correction to record
02/01/2021	35,689	Marino Chrysler Jeep Dodge Chicago, IL 773-777-2000 marinocjd.com ★ 4.5 / 5.0 1,225 Verified Reviews ♥ 15,312 Customer Favorites		Vehicle serviced -Maintenance inspection completed -Oil and filter changed -Tires rotated
06/13/2021		Illinois Motor Vehicle Dept. Chicago, IL		Registration issued or renewed

01/06/2022	43,475	Texas Motor Vehicle Dept. Austin, TX Title #22735544557083209		Title issued or updated -Registration updated when owner moved the vehicle to a new location -Vehicle color noted as White
03/21/2022	46,932	Nyle Maxwell Chrysler Dodge Jeep Austin, TX 512-493-8117 nylemaxwellsupercenter.com ★ 4.5 / 5.0 848 Verified Reviews ♥ 153 Customer Favorites		Vehicle serviced -Maintenance inspection completed -Oil and filter changed
04/01/2022		Walmart Auto Care Center Austin, TX 512-257-7689 https://www.walmart.com ★ 4.3 / 5.0 203 Verified Reviews ♥ 6 Customer Favorites		Vehicle serviced -Tire condition and pressure checked -Tire pressure sensor replaced -Tire(s) balanced -Tire(s) replaced
10/19/2022	53,608	Walmart Auto Care Center Austin, TX 512-257-7689 https://www.walmart.com ★ 4.3 / 5.0 203 Verified Reviews ♥ 6 Customer Favorites		Vehicle serviced -Oil and filter changed
10/26/2022	53,754	Walmart Auto Care Center Cedar Park, TX 512-528-8984 https://www.walmart.com ★ 4.2 / 5.0 205 Verified Reviews		Vehicle serviced
12/23/2022	55,320	Walmart Auto Care Center Austin, TX 512-257-7689 https://www.walmart.com ★ 4.3 / 5.0 203 Verified Reviews ♥ 6 Customer Favorites		Vehicle serviced -Battery/charging system checked -Battery replaced
06/17/2023	59,903	Walmart Auto Care Center Austin, TX 512-257-7689 https://www.walmart.com ★ 4.3 / 5.0 203 Verified Reviews ♥ 6 Customer Favorites		Vehicle serviced -Oil and filter changed
07/13/2023	60,517	Qualtech Automotive Austin, TX 512-335-6043 qualtechauto.com/ ★ 4.9 / 5.0 308 Verified Reviews ♥ 14 Customer Favorites		Vehicle serviced -Emissions inspection performed
07/13/2023		Texas Inspection Station Austin, TX		Passed emissions inspection
09/01/2023		Texas Motor Vehicle Dept. Austin, TX Title #22735544557083209		Registration issued or renewed -Passed safety inspection -Vehicle color noted as White

06/11/2024	73,449	Walmart Auto Care Center Austin, TX 512-257-7689 https://www.walmart.com ★ 4.3 / 5.0 203 Verified Reviews ♥ 6 Customer Favorites		Vehicle serviced -Oil and filter changed
07/26/2024	75,680	A Plus Transmission Specialists Cedar Park 6 Cedar Park, TX 512-910-3042 ★ 4.7 / 5.0 27 Verified Reviews ♥ 2 Customer Favorites		Vehicle serviced -Transmission checked -Transmission fluid changed
08/09/2024	76,092	Texas Inspection Station Austin, TX		Failed emissions inspection
08/09/2024		Qualtech Automotive Austin, TX 512-335-6043 qualtechauto.com/ ★ 4.9 / 5.0 308 Verified Reviews ♥ 14 Customer Favorites		Vehicle serviced -Emissions inspection performed
08/12/2024	76,257	Texas Inspection Station Austin, TX		Passed emissions inspection
09/01/2024		Texas Motor Vehicle Dept. Austin, TX Title #22735544557083209		Registration issued or renewed -Passed safety inspection -Vehicle color noted as White
09/29/2024	78,292	Walmart Auto Care Center Austin, TX 512-257-7689 https://www.walmart.com ★ 4.3 / 5.0 203 Verified Reviews ♥ 6 Customer Favorites		Vehicle serviced -Oil and filter changed -Tire pressure monitoring system checked -Tire(s) replaced
05/02/2025	80,849	Walmart Auto Care Center Austin, TX 512-257-7689 https://www.walmart.com ★ 4.3 / 5.0 203 Verified Reviews ♥ 6 Customer Favorites		Vehicle serviced -Oil and filter changed
05/19/2025	81,049	Walmart Auto Care Center Austin, TX 512-257-7689 https://www.walmart.com ★ 4.3 / 5.0 203 Verified Reviews ♥ 6 Customer Favorites		Vehicle serviced -Battery/charging system checked -Battery replaced
08/27/2025	81,937	Christian Brothers Automotive Austin, TX 512-918-2886 cbac.com/cedarpark ★ 4.8 / 5.0 56 Verified Reviews ♥ 626 Customer Favorites		Vehicle serviced -Emissions or safety inspection performed

08/27/2025		Texas Inspection Station Austin, TX		Passed emissions inspection
09/01/2025		Texas Motor Vehicle Dept. Austin, TX Title #22735544557083209		Registration issued or renewed -Passed safety inspection -Vehicle color noted as White
05/08/2026	84,436	Nyle Maxwell Chrysler Dodge Jeep Austin, TX 512-493-8117 nylemaxwellsupercenter.com ★ 4.5 / 5.0 848 Verified Reviews ♥ 153 Customer Favorites		Vehicle serviced -Maintenance inspection completed -Oil and filter changed
06/22/2026	85,019	Nyle Maxwell Chrysler Dodge Jeep Austin, TX 512-493-8117 nylemaxwellsupercenter.com ★ 4.5 / 5.0 848 Verified Reviews ♥ 153 Customer Favorites		Vehicle serviced

Have Questions? Consumers, please visit our Help Center at www.carfax.com. Dealers or Subscribers, please visit our Help Center at www.carfaxonline.com.

Glossary

Damage Indicator

Damage can be a result of many different types of events. Examples include contact with objects (other cars, trees, traffic signs, road debris, etc), vandalism, or weather-related events. Not every damage event is reported to CARFAX. As details about the damage event become available, those additional details are added to the CARFAX Vehicle History Report. CARFAX recommends that you have this vehicle inspected by a qualified mechanic.

Damage Severity

Damage events result in one of the following severity levels:

- Minor: Generally, minor damage is cosmetic (including dents or scratches), may only require reconditioning, and typically does not compromise a vehicle's operation and/or safety.
- Moderate: Moderate damage may affect multiple components of the vehicle and may impair the vehicle's operation and/or safety.
- Severe: Severe damage usually affects multiple components of the vehicle and is likely to compromise the vehicle's operation and/or safety.

CARFAX recommends getting a pre-purchase inspection at a certified collision repair facility.

Failed Emissions Inspection

The emissions check performed during a vehicle inspection indicated the vehicle was emitting more than allowable emissions standards and/or had missing or modified parts. Repeated failed emissions records can indicate engine problems and CARFAX recommends you have the vehicle inspected.

First Owner

When the first owner(s) obtains a title from a Department of Motor Vehicles as proof of ownership.

New Owner Reported

When a vehicle is sold to a new owner, the Title must be transferred to the new owner(s) at a Department of Motor Vehicles.

Ownership History

CARFAX defines an owner as an individual or business that possesses and uses a vehicle. Not all title transactions represent changes in ownership. To provide estimated number of owners, CARFAX proprietary technology analyzes all the events in a vehicle history. Estimated ownership is available for vehicles manufactured after 1991 and titled solely in the US including Puerto Rico. Dealers sometimes opt to take ownership of a vehicle and are required to in the following states: Maine, Massachusetts, New Jersey, Ohio, Oklahoma, Pennsylvania and South Dakota. Please consider this as you review a vehicle's estimated ownership history.

Title Issued

A state issues a title to provide a vehicle owner with proof of ownership. Each title has a unique number. Each title or registration record on a CARFAX report does not necessarily indicate a change in ownership. In Canada, a registration and bill of sale are used as proof of ownership.

Follow Us:



[facebook.com/CARFAX](https://www.facebook.com/CARFAX)



@CARFAXinc



About CARFAX

CARFAX DEPENDS ON ITS SOURCES FOR THE ACCURACY AND RELIABILITY OF ITS INFORMATION. THEREFORE, NO RESPONSIBILITY IS ASSUMED BY CARFAX OR ITS AGENTS FOR ERRORS OR OMISSIONS IN THIS REPORT. CARFAX FURTHER EXPRESSLY DISCLAIMS ALL WARRANTIES, EXPRESS OR IMPLIED, INCLUDING ANY IMPLIED WARRANTIES OF MERCHANTABILITY OR FITNESS FOR A PARTICULAR PURPOSE.

Customer Signature

Date

Dealer Signature

Date

